

DESCRIPTION

- Indoor eco-designed analogue clock.
- Hour-Minute display.
- Dial markings: arabic figures or minute notches.
- Autonomous power supply by solar cells.
- Construction using bio-based and recycled materials.
- Optimal viewing distance: 20 m.
- Fixing disc supplied.
- 2 possible colours: black or white.
- Model(s): wireless DHF.



COMPLIANCE

- Directive EMC 2014/30/EU,
- Directive LVD 2014/35/EU,
- Directive RED 2014/53/EU.

TECHNICAL FEATURES

- **Power supply**..... 2 integrated solar cells. No batteries (or cells).
- **Construction**..... PC-ABS, including 2 parts in recycled PC-ABS.
- **Protective glass**..... Poly methyl methacrylate (PMMA).
- **Protection index**..... IP54, IK06.
- **Sound level**..... < 20dB (normal operation).
- **Operating temperatures**..... -5° to +50°C.
- **Weight**..... 0,8 kg.
- **Dimensions**..... See below.

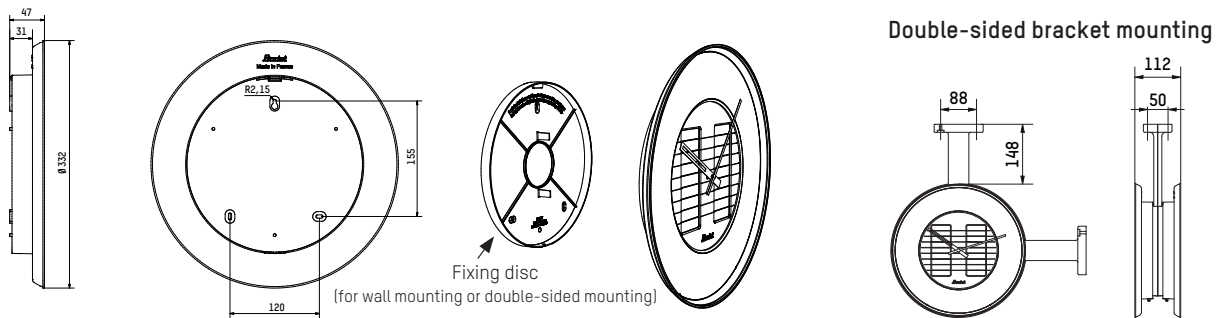

Dimensions in mm



MOVEMENTS AND SYNCHRONISATION

| Movements | Description |
|--|--|
|  DHF Radio | The DHF clocks retrieve the time signal sent by the master clock via a radio signal and synchronise automatically. If radio reception is poor, the clocks keep on running using their own time base. |

PRE-REQUISITES / OPERATING CONDITIONS

 • Minimum light level for operating and charging: 100 Lux.
 • In order to operate continuously, the clock must be exposed to an illumination of 150 lux during 10 hours, 5 days a week.

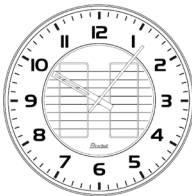
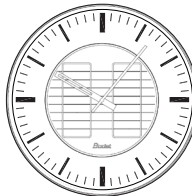
REFERENCES

| Movements | Dial models (x) : | Dial colours (y) : |
|----------------------|--|---|
| 986 2xy DHF Radio | 1= Arabic figures 2= Min. notches | 1= White 2= Black |
| |   |   |

x and y: refer to the illustrations.

ACCESSORIES

- 986 001.. Bracket arm for double-sided mounting

